

MAGICFX® SHOT BASE WIRELESS



PRODUCT CODE : MFX0360
VERSION : 1.0
DATE : 20.03.2013



1. CONGRATULATIONS!

You have bought a great new product from MAGICFX®.

MAGIC FX is a Dutch manufacturer of professional special effects machines and equipment. We have been experts in special effects since our establishment in 1995. All our products are made under the brand name MAGICFX® which by now has acquired a great reputation on account of its quality and reliability. All products are made in accordance with the European Machinery Directive. MAGIC FX manages the entire production process in-house, from the design stages and prototyping to production. In short, we cover everything from concept to ready-to-use product.



Moreover, MAGIC FX is Europe's largest supplier of high-quality and fireproof confetti products and streamers. Thanks to our very large stock levels, we can deliver quickly and at low prices.

MAGICFX® is used by special effects professionals all over the world and our products are distributed through a dealer network which covers more than 80 countries.

Congratulations and enjoy your purchase!

MAGIC:CFX®

2. CE MARKING

	<p>PLEASE NOTE: We presume that you, your employees and others who use or come into contact with the machine are familiar with how the machine must be dealt with. This includes the correct use, maintenance and repair of the machine as described in this user manual. This also means that the employees are familiar with the use of machines through training or experience.</p>
	<p>DANGER WARNING: Only use the Shot Base Wireless in accordance with the regulations and instructions in this manual. Consult MAGIC FX in case of doubt.</p>

Disclaimers:

MAGIC FX B.V. excludes liability for unsafe situations, accidents and damage that are the result of:

- Disregard for the warnings or regulations as set out on the Shot Base Wireless or in this documentation.
- Use for other purposes or under other circumstances than those set out in this documentation.
- Alterations to the Shot Base Wireless. This also includes the use of replacement parts other than the original ones.
- Insufficient maintenance.
- Unauthorised removal of safety caps and/or safeguards.
- Incompetent operation of the machine.

MAGIC FX B.V. is not liable for any consequential loss in the event of a Shot Base Wireless breakdown.

© Copyright 2012

All rights are reserved. Nothing from this manual may be duplicated, or kept in an automated data file, or made public, or in any form or manner, whether electronically, mechanically, by photocopying, by incorporation, or in any other manner duplicated without the permission of MAGIC FX B.V.

MAGIC FX at all times retains the right to make alterations without the direct knowledge of the client. The contents of this user manual can also be changed.

Please contact the technical department of your supplier for extra information with regard to, for example, maintenance and repair. This user manual has been drawn up with the utmost care. MAGIC FX cannot be held responsible for any mistakes made in this publication or for any consequences thereof.

3. DECLARATION OF CONFORMITY

DECLARATION OF CONFORMITY (according to Annex II.1.A of the Machinery Directive)



Concerning the Machinery Directive.
We; MAGIC FX B.V.
Schouwrooij 27
5281 RE Boxtel
The Netherlands

State under personal responsibility:
We are the manufacturer of the product:

MFX0360 - MAGICFX® Shot Base Wireless

to which this statement relates and which is in accordance with the provisions of the following Directive(s):

- Machinery Directive 2006/42/EC
- Low Voltage Directive 2006/95/EC
- EMC Directive 2004/108/EG

The following harmonising standards have been applied:

- NEN-EN-ISO 12100
- NEN-EN-ISO 60204-1

Place : Boxtel
Date : 15-10-2012

Name: MAGIC FX

A handwritten signature in black ink, appearing to be 'B. Veroude', written over a horizontal line. The signature is stylized and includes a large circular flourish on the left side.

Director: B. Veroude





4. FOREWORD

This manual describes the MAGICFX® Shot Base Wireless. The information in this manual is important for the proper and safe functioning of the Shot Base Wireless. If you are not familiar with the installation, operation, preventative maintenance etc. of the Shot Base Wireless then please read this user manual carefully from beginning to end. MAGIC FX also insists that all new users (operators, installers, maintenance workers and cleaners) receive a training course in which this user manual can serve as a starting point.

MAGIC FX advises that the original of this user manual, including appendices, is kept at a safe and central place. It is best that another original or copy is kept close to the Shot Base Wireless at the workplace.

If you are familiar with these matters, then you can use this manual as a work of reference.

The following standard markings are used in this manual for drawing attention to certain subjects or actions.

	<p>TIP: Gives you suggestions and advice regarding easier or more convenient ways to carry out certain tasks.</p>
	<p>PLEASE NOTE: A comment with additional information: alerts you to certain problems.</p>
	<p>CAUTION: The machine can be damaged if you do not follow the procedures carefully.</p>
	<p>DANGER WARNING: You can get (seriously) hurt if you do not carefully carry out the procedures.</p>

CONTENTS

1.	CONGRATULATIONS!	1
2.	CE MARKING.....	2
3.	DECLARATION OF CONFORMITY.....	3
4.	FOREWORD	4
5.	INTRODUCTION	6
5.1	DESCRIPTION AND APPLICATION OF THE SHOT BASE WIRELESS	6
5.2	NECESSARY ACCESSORIES.....	6
5.3	CANNONS.....	6
6.	SAFETY	8
6.1	INTRODUCTION	8
6.2	GENERAL SAFETY RULES.....	8
6.3	WARNINGS.....	8
6.4	LIPO BATTERY	9
7.	PARTS	10
8.	ACCESSORIES.....	11
9.	PREPARATIONS	12
10.	INSTALLATION	13
11.	USAGE	16
12.	SWITCHING OFF	18
13.	TROUBLESHOOTING	20
14.	TECHNICAL SPECIFICATIONS	20
15.	MAINTENANCE	20
16.	GUARANTEE	20

5. INTRODUCTION

5.1 DESCRIPTION AND APPLICATION OF THE SHOT BASE WIRELESS

The Shot Base Wireless is a confetti shooting system which has been specially developed to easily shoot electric cannons from a podium or truss.

The Shot Base Wireless can be used with electric confetti cannons as well as with electric streamer cannons.

The Shot Base Wireless is controlled by a remote.

As the Shot Base Wireless can be used in various ways, it is important to read this user manual carefully from beginning to end before you start operating the machine.

Any use other than that described above excludes your supplier from any liability.

5.2 NECESSARY ACCESSORIES

The following parts belong to the Shot Base Wireless:

		
<p>Handleiding</p>	<p>MFX0308 – Power cable</p>	<p>Electric Cannons</p>
		
<p>Remote 4 or Remote 8</p>		

Table 5.1

5.3 CANNONS

The Shot Base Wireless offers the possibility to work with approved electric confetti and streamer cannons. The Shot Base Wireless is not suitable for cannons other than those described below.

		
<p>40cm Electric cannon</p>	<p>80cm Electric cannon</p>	<p>Other confetti cannons</p>

Table 5.2

The following types of electric cannons are possible:







TYPE CANNON	CONTENT	CANNON LENGTH	OUTPUT
	CONFETTI (150g)	40CM	5M
	STREAMERS (150g)	40CM	12M
	CONFETTI (300g)	80CM	12M
	STREAMERS (300g)	80CM	20M

Table 5.3

All pre-filled cannons are for one-off use only.

	DANGER WARNING: Metallic products are heavier and will therefore have a larger output.
	DANGER WARNING: The electric cannons contain pressure containers which fire off the confetti/streamers under a lot of pressure. Therefore always make sure there is a free shooting range.

6. SAFETY

6.1 INTRODUCTION

The Shot Base Wireless has been designed and constructed in such a manner that it can be used safely. This applies to the use, the circumstances and the regulations as described in this documentation. Reading this documentation and following the instructions are therefore necessary for everyone who is authorised to work with the Shot Base Wireless.

The Shot Base Wireless must be placed and used in surroundings that preferably:

- Have a reasonably stable temperature of between 0 and 30°C.
- Have a relative humidity degree of no more than 75%.
- Are reasonably free of dust, corrosive gases and high concentrations of organic vapours.

6.2 GENERAL SAFETY RULES

- Only use the Shot Base Wireless if there are no people, animals or other objects in the direction of the electric cannon within the output distance. The shooting direction is the direction in which the electric cannon in the Shot Base Wireless is pointed. The output distance depends on the content and length of the electric cannons.
- Make sure that children, unauthorised people and animals do not obtain access to the Shot Base Wireless!
- Do not take hold of the Shot Base Wireless while it is working or is switched on. Also, when the Shot Base Wireless is not working, the electric cannon may still be filled.
- Safety devices may not be removed or disabled.
- All required safety devices must be in good condition and function properly.
- Ensure sufficient lighting of the surroundings.
- Keep the workplace clean.
- Only authorised persons may carry out work with the Shot Base Wireless.

6.3 WARNINGS

Warning texts have been attached to the Shot Base Wireless. With regard to these the following rules apply:

- These texts may not be removed or damaged. The operator must regularly check if this is the case.
- The operator must ensure that the texts are and remain clearly visible and legible.



DANGER WARNING:
One must replace texts or signs if these are absent, damaged or illegible.

Sign and explanation	Photo
<div style="text-align: center;">  <p>PIC 616 Follow the instructions</p> </div>	
<p>The operator must be told that he/she may only operate the Shot Base Wireless after reading the user manual.</p> <p>A warning is given for this by means of the command sign of PIC 616. This sign should be attached to the type sign. See also the photo.</p>	

Sign and explanation	Photo
<div style="text-align: center;">  <p>PIC 307 Danger: high voltage</p> </div>	
<p>A warning must be given about the machine's high voltage by using the caution sign PIC 307. This sign must be attached to the Shot Base Wireless. See also the added photo.</p>	

6.4 LIPO BATTERY

The Shot Base Wireless is equipped with an 2200mAh 3 cells lithium polymer (LiPo) battery which enables the Shot Base Wireless to be used without constant power supply.

7. PARTS

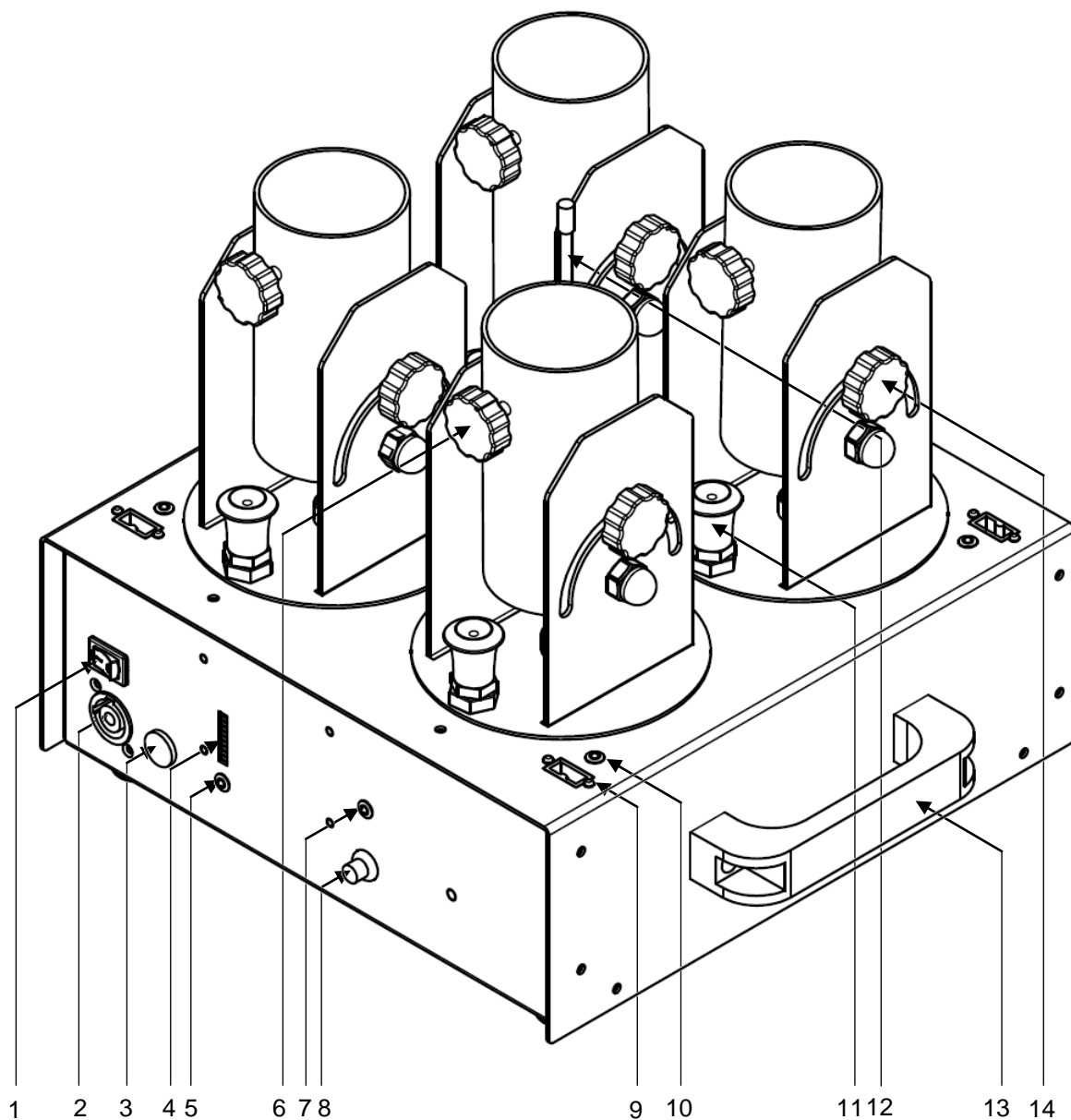

- | | |
|------------------|---------------------|
| 1. Power switch | 8. Learn button |
| 2. Power input | 9. Cannon connector |
| 3. Fuse holder | 10. Indicator LED |
| 4. Battery level | 11. Twist lock |
| 5. Charging LED | 12. Antenna |
| 6. Cannon nut | 13. Handle |
| 7. Learn LED | 14. Aim nut |

8. ACCESSORIES

		
MFX0302 – Cannon clamp	MFX3103 – Twenty clamp M10	MFX0308 – Power cable
		
MFX3206 – Remote 4	MFX3207 – Remote 8	MFX3208 – Battery for remote

Table 8.1

You can order these parts and accessories from:

MAGIC FX B.V.
Schouwrooij 27
NL-5281 RE BOXTEL
The Netherlands
T. +31(0)411 63 50 13
F. +31(0)411 63 50 12
W. <http://www.magicfx.eu>
E. info@magicfx.eu



9. PREPARATIONS

Unpack the Shot Base Wireless. Dispose of the packaging material without harming the environment. Inspect the machine for any damage. If damage is noticed this must be reported to MAGIC FX.

1.



If u want to use the Shot Base Wireless on a location without an constant power supply u need to charge the Shot Base Wireless first.

To charge the Shot Base Wireless u need a powerCON cable. Connect the powerCON to the POWER INPUT and the other end to a power source (230V~50/60Hz)

The CHARGING BATTERY LED will light up and the battery is charged.

2.



When the Shot Base Wireless is fully charged (the LED CHARGING BATTERY is green) u can choose to unplug the Shot Base Wireless and use it wireless





The Shot Base Wireless can also be used while plugged in.

3.



Next unplug the powerCON to move or store the Shot Base Wireless.

10. INSTALLATION

	CAUTION: The machine can be damaged if you do not follow the procedures carefully.
	DANGER WARNING: The MAGICFX® Shot Base Wireless may only be installed by adults and authorised persons.

Prepare the Shot Base Wireless for use as follows:

1.



Flip the powerswitch to turn on the Shot Base Wireless.



The current charge of the battery is indicated by the BATTERY indicator. This is lit up when the Shot Base Wireless is turned on.

2.



To make the Shot Base Wireless react to a remote 4/8 turn on the remote and press the LEARN SWITCH on the Shot Base Wireless, now the LEARN LED will blink once. This means output 1 can be programmed to button on the remote.



Press the button on the remote u want to assign to output 1. The LEARN LED on the Shot Base Wireless will light up. Press the same button on the remote again to confirm your setting. The LEARN LED will blink to confirm your setting.

3.

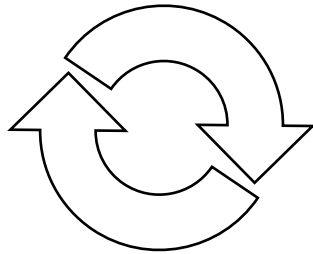

To program output 2, 3 and 4 u need to press the LEARN SWITCH on the Shot Base Wireless if it has blinked once u selected output 1. press the LEARN SWITCH again and the LEARN LED will blink twice, this means u selected output 2. Repeat this action to select output 3 or 4.



It's possible to use multiple remotes with one Shot Base Wireless. It's also possible to switch multiple outputs with one button on the remote.

**4
a.**



If u want to use the Shot Base Wireless standing: place the Shot Base Wireless on a flat and stable surface.



5.
b.



If u want to use the Shot Base Wireless mounted in a truss system: mount 2 trussclamps (MFX3104) to the bottom of the Shot Base Wireless.

Next place the Shot Base Wireless in the truss system and secure the trussclamps.

11. USAGE

	<p>TIP: Gives you suggestions and advice regarding easier or more convenient ways to carry out certain tasks.</p>
	<p>CAUTION: The machine can be damaged, if you do not follow these procedures carefully.</p>
	<p>DANGER WARNING: The MAGICFX® Shot Base Wireless may only be installed by adults and authorised persons.</p> <p>The Shot Base Wireless may only be operated if all parts are completely and correctly installed/connected.</p>

For using the Shot Base Wireless take the following steps:

1.



Now u can load the Shot Base Wireless with the desired cannons, Place the cannons in the cannon holders and secure them by tightening the bolts.

2.



Next connect the connectors from the cannons to the ouput on the Shot Base Wireless.



When the cable on the cannon is to short u can use the extensioncord delivered with the Shot Base Wireless.

3.



Now press the preprogrammed buttons on the remote to activate the cannons.



Always look before shooting if there is no one in front of the output direction of the cannons.



The maximum distance between remote and Shot Base Wireless is 1000m (open field) Use this standard to use the machine flawlessly.

12. SWITCHING OFF

To switch off the Shot Base Wireless, take the following steps:

1.



Shut off all remote's

2.



Turn off the Shot Base Wireless.

3.



If it is still connected unplug the powerCON connector

4.



Remove all cannon's from the Shot Base Wireless.

5.



The Shot Base Wireless is now turned off



Always charge the battery again before storing it, this way the battery stays in optimum condition.

13. TROUBLESHOOTING

- The Shot Base Wireless doesn't react to a remote 4/8.

This problem has multiple causes: first check if the remote is switched on (the red LED is lit and the switch is away from the antenna) Press on one of the buttons of the remote 4/8 to send a signal to the Shot Base Wireless, if the LEARN LED on the Shot Base Wireless blinks fast the signal is received by the Shot Base Wireless in this case the Shot Base Wireless needs to be programmed to the remote. How to do this view page 10 of this manual.

- The Shot Base Wireless doesn't receive any signal (no blinking LEARN LED).

When you are sure the remote is operating right and it still doesn't react to the signal there are probably multiple devices also transmitting on the frequency of 434MHz. This can cause bad or no reception by the Shot Base Wireless. Turn other transmitters off to use the Shot Base Wireless flawlessly.

- One or more outputs don't work.

Probably a fuse is burned through. Replace the fuse by unscrewing the fuseholder and replacing the fuse by a new 10A fuse.

- The Shot Base Wireless is still malfunctioning after troubleshooting

Always contact your dealer or the technical service of MAGIC FX first in case of uncertainties, questions about the Shot Base Wireless works or other issues with regard to the Shot Base Wireless.

14. TECHNICAL SPECIFICATIONS

Measurements and weight	Length:	310mm (12.2")
	Width:	380mm (14.96")
	Height:	295mm (11.61")
	Weight:	9,85 Kg (21.7lbs.)
Power	Input:	AC 230V~50-60Hz
	Consumption:	400W
	Fuse:	10A 250V 5x20mm
	Battery internal:	Lithium Polymeer Accu 3-Cell 11.1 vdc 2200mAh
	Battery Remote:	CR2032
Wireless	Frequency:	434.535Mhz
	RF Output:	3 ~ 10mW

Design and product specifications can be changed without prior notification.

15. MAINTENANCE

To achieve the maximum service life of the Shot Base Wireless you must regularly clean the Shot Base Wireless and test if it is working correctly.

Should the Shot Base Wireless not work for some reason then please contact MAGIC FX.

	<p>DANGER WARNING: Do not replace parts yourself; always consult MAGIC FX if necessary.</p>
---	--

16. GUARANTEE

A manufacturer's guarantee of 3 years applies to the MAGIC FX Shot Base Wireless.

- The guarantee expires if the Shot Base Wireless is used for improper purposes and for applications which are not stated in this manual.
- The guarantee also expires if the machine is used incorrectly or in violation of the regulations.
- The guarantee expires if the machine is altered without permission from the supplier.