

USER MANUAL

SPARKULAR® JET

V3.2

2022/10/18



Showven Technologies Co., Ltd.

Thanks for choosing SPARKULAR® JET, we wish it will sparks up your show. Please read the following manual carefully before operating this product.

Δ Safety Instructions

- ⚠ Unauthorized repair are prohibited, it may cause serious incident.
- ⚠ SPARKULAR® JET can be used in rain, but after use please clean it, and store it at dry environment.
- ⚠ Make sure lid of feeding hopper are well covered when use SPARKULAR® JET.
- ⚠ Accidentally burning of consumable can only use sands to extinguish.
- ⚠ Consumable should keep away from moisture and stored in a dry sealed environment.
- ⚠ Check whether there is consumable aggregate in the output nozzle both before and after each show, if any, please clean it up, or it will affect the firing effect or even damage SPARKULAR® JET.
- ⚠ Please be noted that there may sparks or remains fall to the ground. Make sure there is no flammable objects such as carpet on the ground within the safety radius around machine.
- ⚠ Maximum cascade of SPARKULAR® JET is 6 units (BT91) / 3 units (BT92) with a standard power cable. Exceed connecting may result in damage or even cause fire.
- ⚠ For better heat dissipation, block the air intake and air outlet is prohibited.
- ⚠ Cover the output nozzle of SPARKULAR® JET is forbidden, inspect the machine before each show, making sure no objects or material will block the output nozzle.
- ⚠ Never touch the nozzle of SPARKULAR® JET, danger of getting burnt
- ⚠ Never touch the sparks which shooting out from the nozzle
- ⚠ Ensure that children, animals and unauthorized persons don't have access to the SPARKULAR® JET.

Safety Distance

- ⚠ Keep audience and flammable material at a minimum distance of 1.5m (when use HC8200 SMALL) or 3m (when use HC8200 MEDIUM or LARGE) from SPARKULAR® JET.
- ⚠ Make sure sparks shoot out from SPARKULAR® JET can NOT touch any objects. And keep a clearance with minimum 2m from the setting maximum effect height.
- ⚠ In windy environment, increase the safety distance according to the wind direction and speed.
- ⚠ The safety zone area shifts accordingly when machine use angled extension tube. Please increase the safety distance in the angled direction.
- ⚠ Sparks and consumables from the machine can lead to serious eye injury. Always wear safety goggles when enter the safety zone.

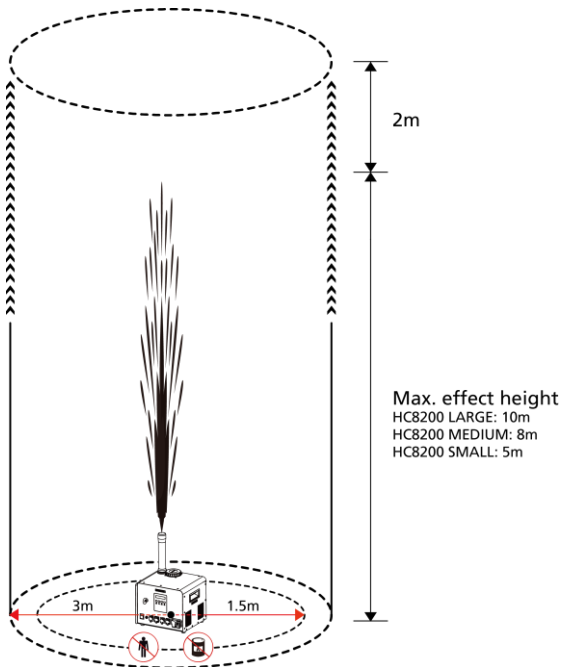

Δ Description

SPARKULAR® JET is another brand new effect originally invented by SHOWVEN®. It generates a flashing SPARKULAR® effect up to 10m. Built-in automatic air compressor, no external pressure tank needed, makes it easier for setup and fewer usage restrictions. It is perfect effects solution for stadium, concerts etc. medium to large events.

Δ Technical Specifications

- \\ **Model:** BT91 / BT92
- \\ **Dimension:** 320×280×300mm
- \\ **Weight:**16.5kg
- \\ **Housing material:** 304 Stainless steel
- \\ **Input:** AC 100V-120V,50/60Hz, Max.cascade:3PCS
AC 200V-240V,50/60Hz, Max.cascade:6PCS
- \\ **Work power:** 350W
- \\ **Work Temp.:** -10 °C~50 °C
- \\ **Effect height:** HC8200 LARGE(8-10m) / HC8200 MEDIUM(6-8m) / SMALL(4-5m)
- \\ **Hopper capacity:** 450g
- \\ **Trigger delay:** 0.6-1s
- \\ **HC8200 consumption:** HC8200 LARGE/MEDIUM 10-15g/shot; HC8200 SMALL 4-6g/shot
- \\ **Interface:** 3-pin and 5-pin DMX IN/OUT, NEUTRIK POWERCON TURE 1
- \\ **Control:** Standard DMX 2 Channels

Δ Structure of SPRKULAR® JET

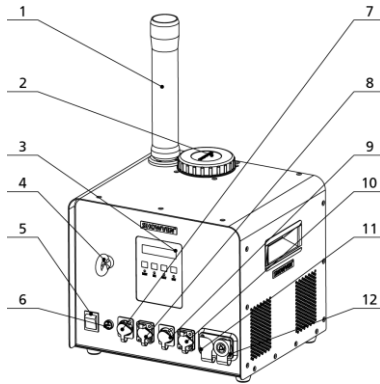

1. Extension Tube
2. Feeding Hopper
3. LCD screen
4. Safety Loop
5. Power Switch
6. Fuse
7. 5-PIN DMX IN
8. 5-PIN DMX OUT
9. 3-PIN DMX IN
10. 3-PIN DMX OUT
11. POWER IN
12. POWER OUT

Diagram of Bottom Panel

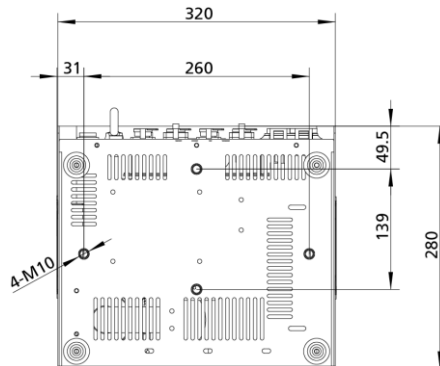

Δ Operation Panel

1. LED display area



READY: Green light flashing means heating up. Turns from flashing into long on, indicates that the machine is ready to work

DMX: Flashing shows that DMX signal is connected, light OFF means there is no DMX signal

FAULT: Light ON when error occurs

HEAT: Light ON when system is heating up

2. Control button area

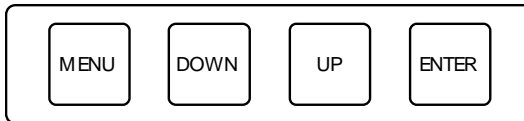

MENU: Press to switch through menu, press and hold for 3s enter advanced menu

DOWN: Parameter down

UP: Parameter up

ENTER: Confirm and save parameters

3. RFID area

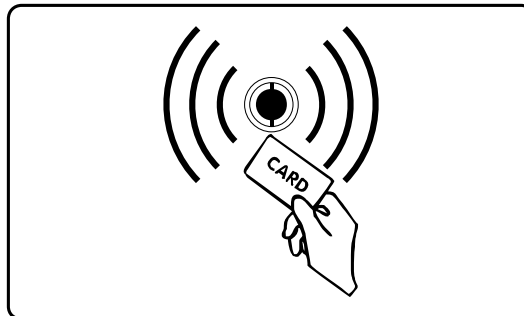

Composite Ti with RFID card, swiping cards used to identify parameters and types of granules. The RFID card is disposable, one card can only use one time.

Δ Interface

1. Main Interface:

DMX:	11	P:	0
T:	19	Delay:	1.0s

First Line: **DMX:** DMX address **P:** pressure value

Second Line: **T:** inner core temp. **Delay:** firing trigger delay

The working principle of the machine is when the firing is triggered, it takes some time (jet delay) for the system to transfer and stimulate the consumables. When it reached the firing trigger delay time, the valve will open automatically and firing.

2. Error information

Error information	Explanation
E0 System IC	1. Emergency stop was executed when firing was triggered, and firing stops. E0 disappear automatically 1min later 2. Too frequent firing in a short period of time, E0 disappear 100s later
E1 Pump Protect	It happens when continuous pressurization fail, probably the pump broken
E2 Temp. Sensor	Temperature sensor is not connected or damage
E3 P Temp. Over	Chassis over-temperature
E4 Time Remain	Activated time for machine is not enough, need to swiping RFID card
E5 K Temp. Over	Heating chamber over-temperature
E6 Heat Fail	Heating fail, if recover automatically, please pay attention to the power supply

3. Setting Menu

Press "MENU" switch through setup menu.

Options	Range	Default	Explanation
Set DMX Address	1-512	1	Set DMX address. Each machine occupy two DMX channels. If controlled by Host Controller, please assign a unique address for each machine
Material Select	Large/Medium/Small	Large	Please select based on the consumable you use
Manual Clear	On/Off	OFF	Clear material manually. Please be careful, do NOT close to the nozzle.

4. Advanced Menu:

Press "MENU" switch through setup menu.

Options	Range	Default	Explanation
Set Temperature	480-620	580	Set inner core temp

Auto Heat	On/Off	ON	ON: machine will heating up and pressurize automatically when power on machine OFF: Need to manually turn on heating up and pressurize on DMX console
Mode Selection	Factory Mode/ User Mode	User Mode	Factory mode is for engineer only. When in Factory mode machine can't controlled by DMX console/host controller
Standby Switch	On/Off	OFF	Standby function. When ON, the machine can firing only when heating up was finished
Ext. Ignite	On/Off	OFF	When use fireworks firing system to firing the machine. Customized design for fireworks customer
Feeding Test	On/Off		Test the feeding structure and feeding motor
Fan Test	On/Off		Test the blowing fan
Tip Over Error	ON/OFF	ON	Tilt function switch

*Please don't change default value without engineer's suggestion from SHOWVEN®

5. DMX Control

SPARKULAR® JET occupy 2 channels.

First channel	Function
0-111	Firing OFF
112-255	Firing. To avoid false triggering, trigger time should maintain above 0.2s.
Second channel	Function
60-80	Clear material, the valve will open when clear material, and clear the consumable remains in the heating chamber. DO remember to clear material after each show.
20-40	Emergency stop, when firing was triggered, operator can stop the firing during this jet delay period. And machine will prompt E0 error
0-10	Pre-heat OFF and auto pressurize OFF (disabled when auto-heat ON)
240-255	Pre-heat ON and auto pressurize ON (disabled when auto-heat ON)

Δ Operation Guide

1. Install SPARKULAR® JET

- SPARKULAR® JET can only installed horizontally. If need to firning SPARKULAR® JET in angles, please use angled extension tube.
- Make sure the machine is securely installed to avoid tipping.
- Check carefully the output nozzle and extension tube of each machine, make sure the output nozzle and extension tube are in good shape and there is no powder aggregate.
- Install the extension tube if use HC8200 MEDIUM and HC8200 LARGE. When use HC8200 SMALL there is no need to install extension tube.
- Beside the standard straight extension tube, there are other two angled extension tubes optional: 30° angled extension tube and 45° angled extension tube.
- Be aware that there will be sparks drop on ground when use angled extension tube.

g) Safety distance should shift accordingly when use angled extension tube.

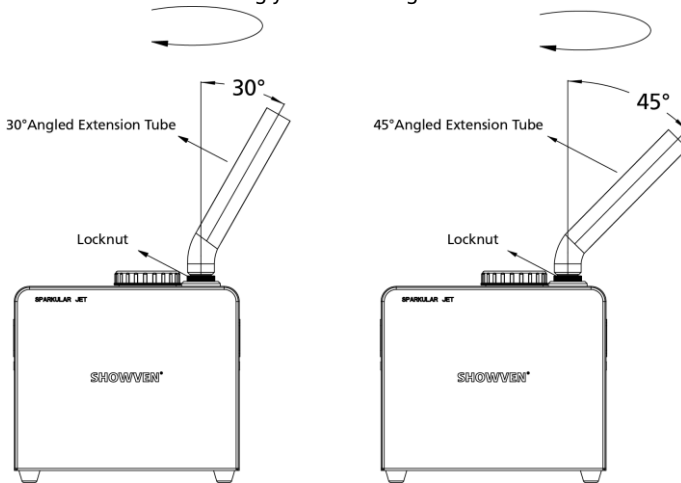

2. Fill SPARKULAR[®] JET

- Open powder bags and fill the feeding hopper. Hopper capacity of SPARKULAR[®] JET is 450g.
- Make sure the powder is originally from SHOWVEN or SHOWVEN authorized distributor, other types of powder may block even damage the machine.
- Choose correct consumable according to the application scenario. SPARKULAR[®] JET can only use HC8200 LARGE, MEDIUM and SMALL.
- Please be noted that there may sparks or remains fall to the ground. Make sure no flammable material on ground in the safety zone.
- Maximum effect height: HC8200 LARGE is 10m, HC8200 MEDIUM is 8m, HC8200 SMALL is 5m.
- Make sure the lid of hopper is locked tight after filling.

3. Connect Power / DMX cable

- Connect a power cable to the POWER IN socket of SPARKULAR[®] JET. Connect the other end of power cable to the power source. Make sure power supply is consistent with the rated voltage of the equipment, and the socket must well grounded.
- If connect machine in sequence, please connect a power link cable to the POWER OUT of previous machine, connect the other end of the power link cable to the POWER IN of next machine.
- The SPARKULAR[®] JET power supply cable maximum allowed cascade is 6 units (BT91) / 3 units (BT92). Do not connect exceed units to a single electrical circuit.
- Power ON all SPARKULAR[®] JET.

- e) Assign DMX address for each unit of SPARKULAR® JET. If use SHOWVEN host controller or FXcommander to control the machine please allocate a unique DMX address for each unit of machine.
- f) Connect a DMX cable to the DMX IN socket of first unit of SPARKULAR® JET, connect the male connector end of DMX cable to your DMX controller (FXcommander, HOST CONTROLLER, light console etc).
- g) Connect a DMX cable to the DMX OUT of previous machine, and the other end of to the DMX IN of next machine. Connect all devices in series in this way.
- h) Suggest to plug in a DMX terminator into the DMX OUT in last unit of machine to improve signal reliability. Signal amplifier is required for long distance (>200m) DMX signal transmission.

4. Activate SPARKULAR® JET by swipe RFID card

- a) Swipe an RFID card. Read the card as show below. SPARKULAR® JET screen flash once if read successfully.
- b) SPARKULAR® JET will report E4 when remaining firing times is less than 10times.
- c) Please note each RFID card come with 200g package HC8200 can increase single machine 30 firing times, the maximum recharge times each time for SPARKULAR® JET is 120 times, when remaining firing times reached 120, it can't recharge anymore RFID card.

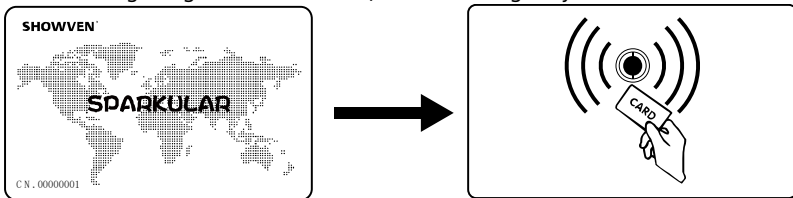

5. Programming and Firing

- a) Programming SPARKULAR® JET, set the "Material Select" in the menu according to the consumable (HC8200 LARGE / MEDIUM / SMALL) you use.
- b) Heating up and pressurize the machine, it takes around 8min.
- c) Make sure the prescribed safety zone is clear.
- d) Suggest to clear material before firing.
- e) Firing. Between each firing there is a firing interval which is for the pressure recovery of the built in pressure tank.
- f) The operator should always have a clear view of the device, so that he/she can stop the show immediately when there is danger.
- g) Clear material for SPARKULAR® JET after show, clear material will remove the remaining particles from heating chamber.

6. Turn off and clean up

- a) Power off SPARKULAR® JET, allow SPARKULAR® JET to cool down.
- b) Disconnect all POWER and DMX cables.

- c) Empty the remaining HC8200 in hopper, and store the remaining HC8200 in a dry sealed bottle for next time use. Never touch the output nozzle of SPARKULAR® JET when empty the hopper. DANGER OF GET BURNT!
- d) Operators can use handheld vacuum cleaner to empty the feeding hopper. Do make sure the machine was cool down when clean it. Do NOT use high-power vacuum cleaners to avoid hot consumables being sucked into the vacuum cleaner from the heating chamber and cause fire.
- e) Clean the surroundings to remove powder residues.

Δ Maintenance

- a) Empty the feeding hopper before shipment of machine.
- b) Empty the feeding hopper if long time not use, for high humidity environment we suggest to empty feeding hopper after each show.
- c) Clear material both before and after the show.

Δ **Warranty Instructions**

- \ Sincere thanks for your choosing our products, you will receive quality service from us
- \ The product warranty period is one year. If there are any quality problems within 7 days after shipping out from our factory, we can exchange a brand new same model machine for you
- \ We will offer free of charge maintenance service for machines which with hardware malfunction (except for the instrument damage caused by human factors) in warranty period. Please don't repair machine without factory permission

Below situations NOT included in warranty service:

- \ Damage caused by use other type of consumable which is not from SHOWVEN[®] or SHOWVEN[®] authorized distributor.
- \ Damage caused by improper transportation, usage, management, and maintenance, or damage caused by human factors;
- \ Disassemble, modify or repair products without permission;
- \ Damage caused by external reasons (lightning strike, power supply etc.)
- \ Damage caused by improper installation or use;

For product damage not included in warranty range, we can provide paid service.

Invoice is necessary when applying for maintenance service from SHOWVEN[®].

SHOWVEN[®]



Showven Technologies Co., Ltd.

Tel: +86-731-83833068

Web: www.showven.cn E-mail: info@showven.cn

Add: No.1 Tengda Road, Liuyang Economic & Technical Development Zone,
410300, Changsha, Hunan, P.R.China